



World · High Definition

70m 4x4 HDMI 2.0 HDBaseT Matrix with 4 HDMI Loop Out Support 4K@60hz YUV4:4:4, 18Gbps, HDR

OPERATION MANUAL



Thank you for purchasing this product. For optimum performance and safety, please read these instructions carefully before connecting, operating or adjusting this product. Please keep this manual for future reference.

SURGE PROTECTION DEVICE RECOMMENDED

This product contains sensitive electrical components that may be damaged by electrical spikes, surges, electric shock, lightning strikes, etc. Use of surge protection systems is highly recommended in order to protect and extend the life of your equipment.

Catalogue

1. Features.....	4
2. Package Contents.....	4
3. Specifications.....	4
4. Panel Descriptions.....	5
4.1 Input / output channel key operation.....	6
4.2 Video switching operation.....	7
4.2.1 Video switch.....	7
4.2.2 Video Control.....	7
The specific operation is as follows:.....	7
4.2.3 Audio Control.....	9
4.3 EDID Set Mode Interface.....	11
4.4 SETUP mode Interface.....	12
1. RS-232 Baud Rate setting.....	12
2. DHCP On/Off setting.....	12
3. Reboot setting.....	13
4. Factory setting.....	13
4.5 INFO mode Interface.....	14
5. Application Diagram.....	15
6. Remote Control Description.....	16
7. IR system.....	16
4. Command Control.....	17
9. PC Tool Control.....	18
“VIDEO” interface description:.....	19
“AUDIO” interface description:.....	21
“EDID” interface description:.....	21
“Network” interface description:.....	23
“System” interface description:.....	24
10. Web Control.....	24
10.1 Change the IP address of your PC.....	25
10.2 Enter Web and Control.....	26
“VIDEO” interface description:.....	26
“AUDIO” interface description:.....	27
“EDID” interface description:.....	28
“Network” interface description:.....	29
System interface description:.....	30
11.RS232 Pass through.....	30
12. RS232 Online upgrading Firmware.....	30
MAINTENANCE.....	32
PRODUCT SERVICE.....	32
WARRANTY.....	32
MAIL-IN SERVICE.....	33

1. Features

- Incorporate HDBaseT technology
- HDMI 2.0 version support 4K@60Hz YUV4:4:4, 18G, HDR10, Dolby Vision (HDMI LOOP)
- Any one of the 4 HDMI Sources to any one of the 4 HDMI Displays
- Each of the 4 outputs includes one HDBaseT output and one HDMI output simultaneously
- Transmit up to 70m under 1080p,40m under 4K@60Hz
- HDCP 2.2/1.4 compliant
- With wide-band Bi-Direction IR routed control(34~56KHz)
- Support 4x Analog Audio input
- Support 4x Analog Audio and 4x SPDIF Audio extraction output
- Support RS232 pass through
- Support Panel Button with LCD, IR Routing, RS232, TCP/IP, PC Tool Control
- Support POC (Receiver powered by HDBaseT Matrix)
- 2U rack design with mounting ears
- AC 110V~220V/50HZ/60HZ input

2. Package Contents

- 1). 1x Main Unit (HDBaseT Matrix) and 4x Receivers
- 2). 1x Power Cable
- 3). 1x Remote control
- 4). 9xIR Transmitter cables, 9x Wide-Band IR Receiver cables
- 5). 1x CD for control software & user manual

3. Specifications

Operating Temperature Range	-5 to +40°C(23 to +104 °F)
Storage Temperature Range	-10 to +60°C(-14 to +140 °F)
Operating Humidity Range	5 to 90 % RH (no condensation)
Input Video Signal	0.5-1.0 volts p-p
Input DDC Signal	5 volts p-p (TTL)
Bandwidth	18Gbit/s
Video Format Supported	4K@60Hz,YUV4:4:4 4k@30Hz/1080P/1080i/720P/576P/480P/576i/480i
HDCP Compliant	HDCP2.2 and HDCP1.4
Output Video	HDMI2.0 and HDMI 1.4 (over HDBaseT and HDMI)
Audio Format Supported	PCM, Dolby5.1, DTS5.1 digital audio
Maximum Transmission Distance	1080P 70m, 4K 40m
Power Consumption	70watts (Max.)
Dimensions	L438 x W394 x H88 mm
Mass (Main Unit)	12 KG

4. Panel Descriptions

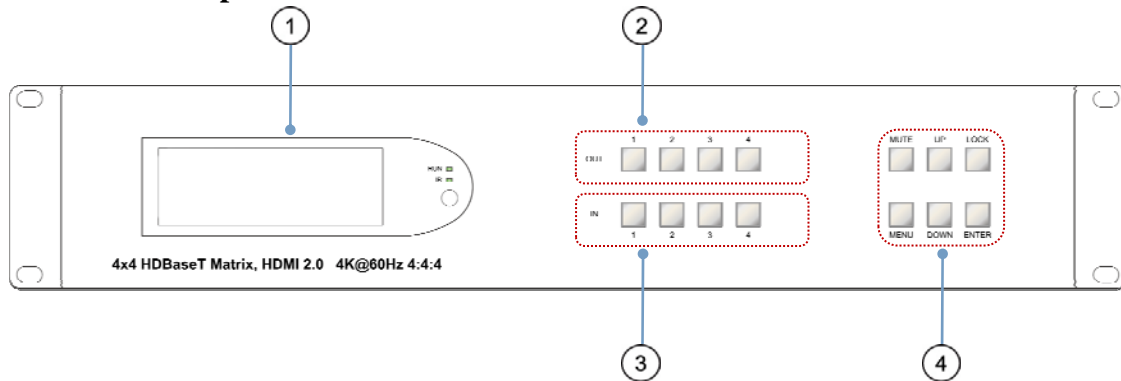

- ① LCD: Showing Matrix information
- ② Output button OUT1~4
- ③ Input button IN1~4
- ④ Function button: MUTE; MENU; UP; DOWN; LOCK; ENTER

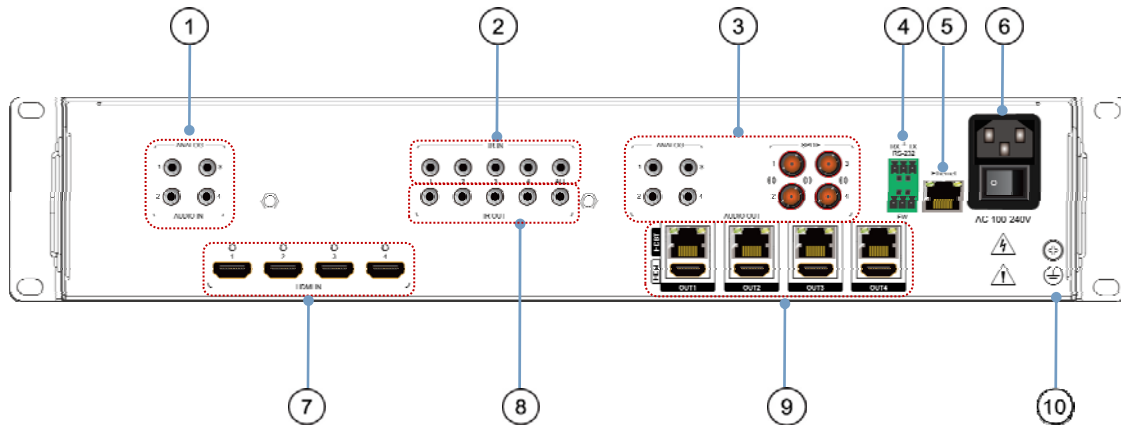

- ① AUDIO IN (Analog x4)
- ② IR in port x4 & All in
- ③ Audio out (analog x4; spdif x4)
- ④ 2xRS232 port (one for update, one for pass through)
- ⑤ Ethernet port
- ⑥ Power On/Off
- ⑦ HDMI Input x4
- ⑧ IR out port x4 & All out
- ⑨ HDBaseT out x4 & HDMI Loop out x4
- ⑩ Grounding



4.1 Input / output channel key operation

Channel	Button method
Any Key	The first operation of the button can wake up the screen
Input 1-4	Directly press the number key, such as input channel 1, and select "1" to press (only when the output port is selected, the input channel number will be valid)
Output 1-4	Directly press the number key, such as the output channel 3, select the key "3" and press it again to cancel the selection; Long press output channel 4 to select all channels, and long press again to cancel
MENU	Function Button; Enter the function option or back to previous option
ENTER	Confirm Button: enter function selection mode
UP	Button for UP option
DOWN	Button for NEXT option
MUTE	Shut down the current selected output, press again to wake up
LOCK	Long press lock (button built-in blue light on), Long press again to cancel lock (button built-in blue light off)

4.2 Video switching operation

4.2.1 Video switch

The signal switch includes 4 free switching channels, which can be configured as input/output according to the requirements, forming a matrix of 1 x 4 ~ 4 x 1, which can switch any input. Signal to 1 channel output or all channel output.

The specific operation is as follows:

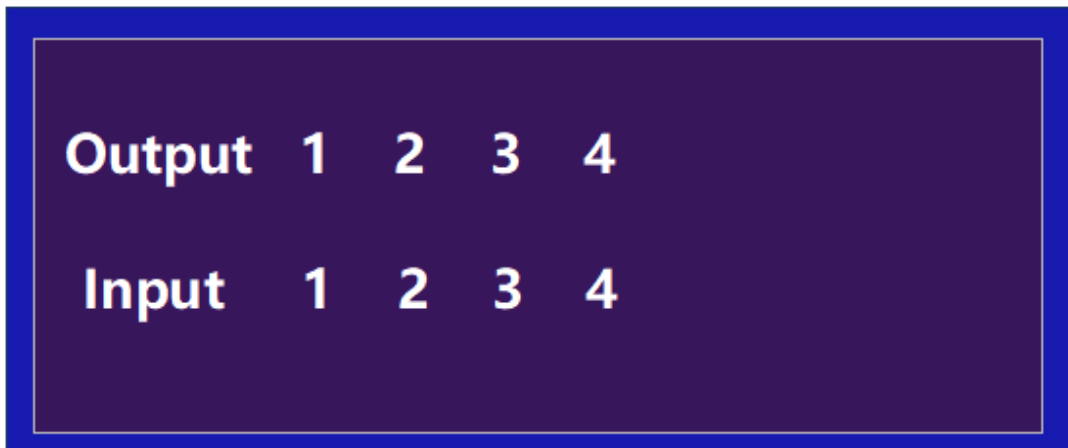

Video switching mode (P1)

Switch the input to the output

Operation format: "output channel" + "input channel"

For Example: Output port 2,3,4 switch to input 2

Operation: Press OUT number "2" "3" "4" + IN number "2" to complete the switch

4.2.2 Video Control

The video interface have two sub menu

1. Video Switch
2. Video On/Off

The specific operation is as follows:

1. Video Switch

Switch any output to one input or all outputs to the same input

- ① Select "Video" in the menu and press "ENTER"
- ② Then use "UP" "DOWN" button to select "Switching"
- ③ Press "ENTER" enter next page
- ④ Press "UP" "DOWN" button to select the output (The fifth port means ALL)
- ⑤ Press "ENTER"
- ⑥ Press "UP" "DOWN" to select the input
- ⑦ Press "ENTER" , Switch Done

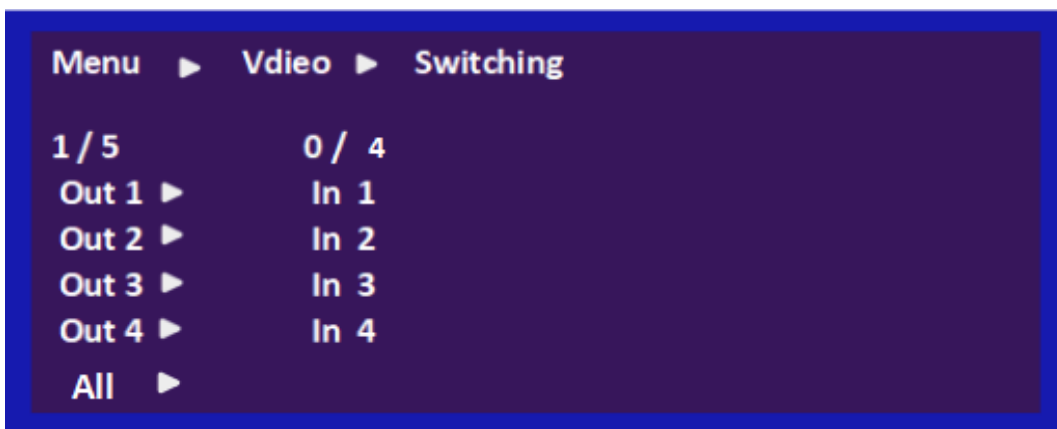
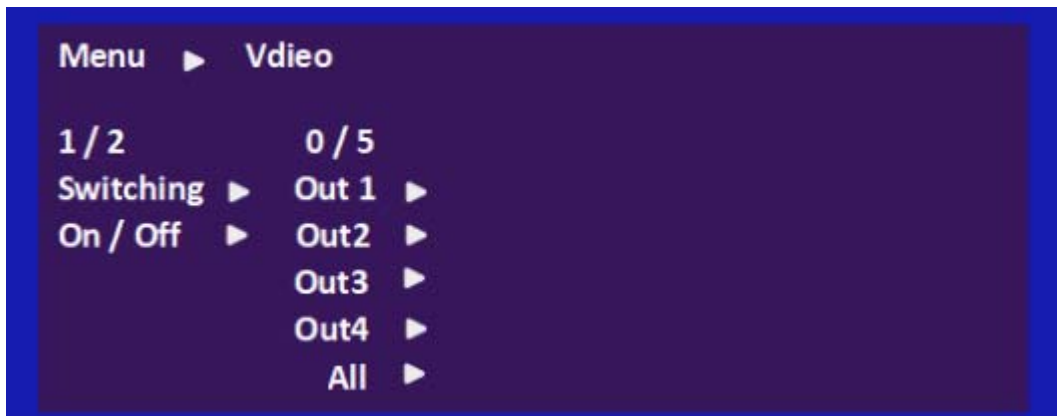

Video Switch (P2)

2.Video On/Off

Turn on/off any output video or all outputs video

- ①Select“Video”in the menu and press“ENTER”
- ②Then use “UP””DOWN”button to select“On/Off”
- ③Press“ENTER”enter next page
- ④Press “UP””DOWN”button to select the output (The fifth port means ALL)
- ⑤Press“ENTER”
- ⑥Press “UP””DOWN”to select “On”or “Off”
- ⑦Press“ENTER” , Switch Done

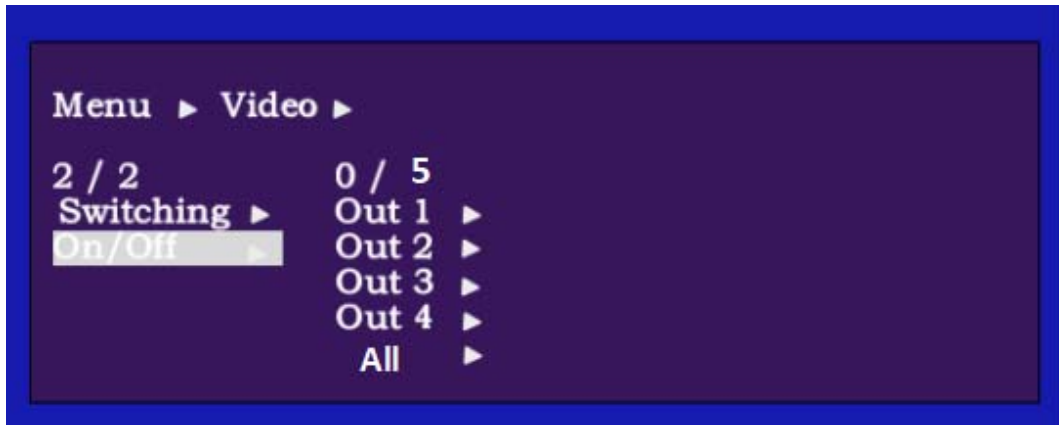

Video On/Off (P3)

4.2.3 Audio Control

The Audio Control have two sub menu

1. Audio Embed
2. Audio De-Embed

The specific operation is as follows:

1. Audio Embed

Audio Embed is for setting input ports audio, it have: Analog; HDMI; Mute setting.

- ① Select "Audio" in the menu and press "ENTER"
- ② Then use "UP" "DOWN" button to select "Embed"
- ③ Press "ENTER" enter next page
- ④ Press "UP" "DOWN" button to select the output (The "In 5" means ALL)
- ⑤ Press "ENTER"
- ⑥ Press "UP" "DOWN" to select the mode: Analog; HDMI; Mute
- ⑦ Press "ENTER" , Done

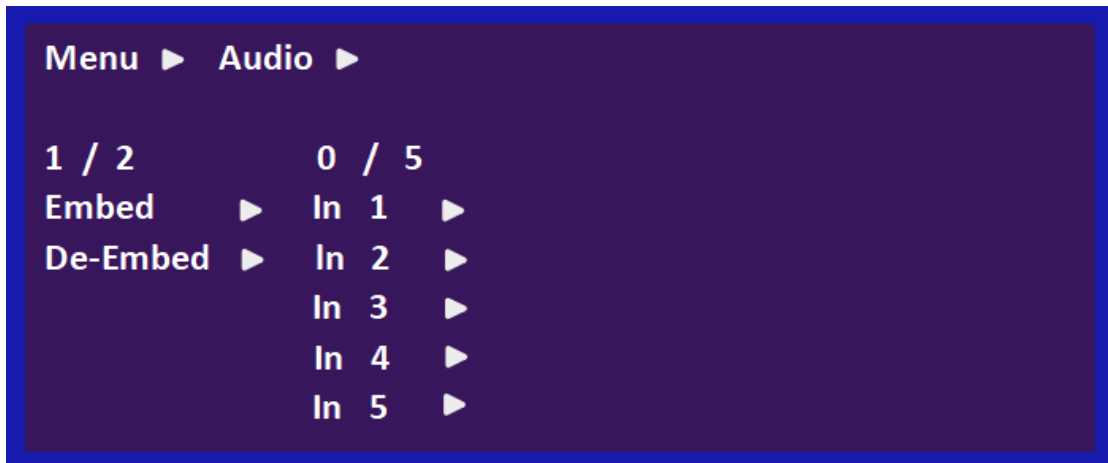

Audio Embed mode (P4)

2. Audio De-Embed

In the mode of Audio De-Embed has Analog and SPDIF in each output port and can switch the audio Mute and Unmute

- ① Select "Audio" in the menu and press "ENTER"
- ② Then use "UP" "DOWN" button to select "De-Embed"
- ③ Press "ENTER" enter next page
- ④ Press "UP" "DOWN" button to select the output (The "Out 5" port means ALL)
- ⑤ Press "ENTER"
- ⑥ Press "UP" "DOWN" to select the mode of Analog and SPDIF audio format
- ⑦ Press "ENTER" , confirm
- ⑧ Press "Mute" or "Unmute" to switch the audio



Audio De-Embed mode (P5)

4.3 EDID Set Mode Interface

Default EDID

Default1	4K60 444 HDR AC-35.1	Default5	4K30 444 3D LPCM2.0
Default2	4K60 444 HDR LPCM7.1	Default6	4K60 420 HDR 3D AC-35.1
Default3	4K60 444 HDR LPCM2.0	Default7	4K60 420 3D LPCM2.0
Default4	4K60 444 LPCM2.0	Default4	1080P60 444 3D LPCM2.0

EDID Mode can set each input's EDID, Include: Default EDID; User EDID; Copy EDID; Copy HDBT EDID.

Specific operations are as follows

- ①Select“EDID”in the menu and press“ENTER”
- ②Then use “UP””DOWN”button to select the input (The “All”means ALL input)
- ③Press“ENTER”enter next page
- ④Press “UP””DOWN”button to select the MODE “default 1”
- ⑤Press“ENTER”to confirm it

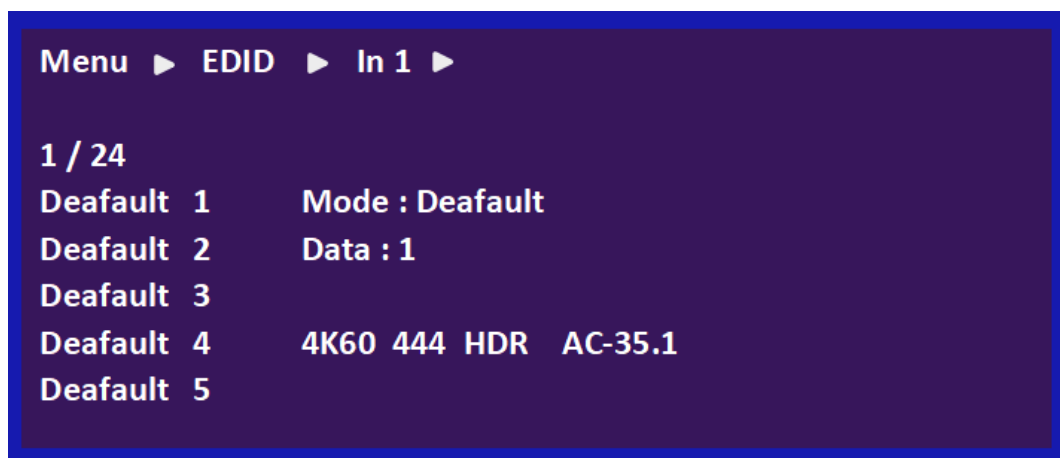
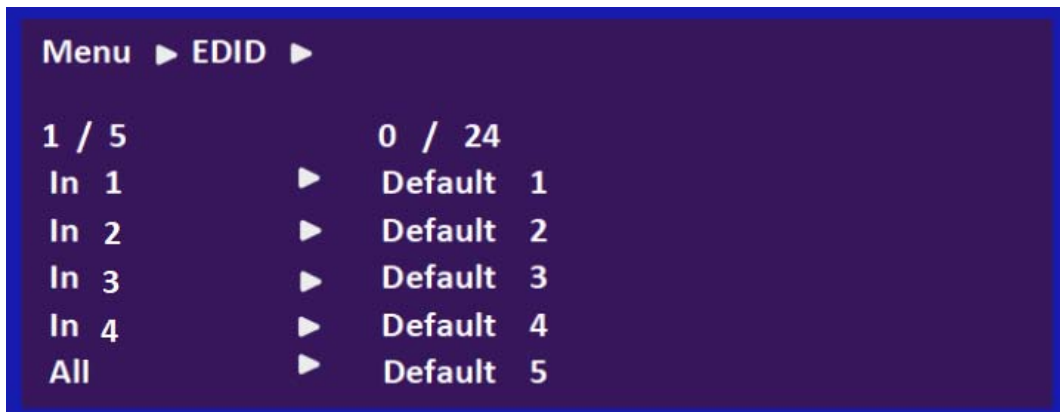

4.4 SETUP mode Interface

SETUP mode can set the device's RS-232 baud rate, DHCP, Reboot, Factory Specific operations are as follows

1. RS-232 Baud Rate setting

It has 7 kinds of baud rates inside the device: 2400; 4400; 9600; 19200; 34400; 57600; 115200
 Default Baud Rate is: 115200

- ① Select "Setup" in the menu and press "ENTER"
- ② Then use "UP" "DOWN" button to select the "BAUD" and press "ENTER"
- ③ Press "UP" "DOWN" button to select the baud rate and press "ENTER" to confirm

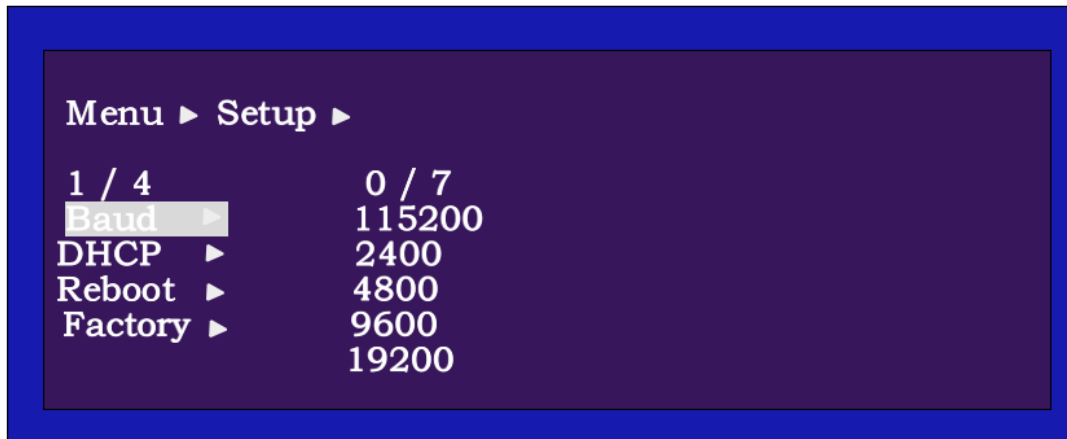

BAUD RATE setting (P7)

2. DHCP On/Off setting

On means Dynamic; Off means Static

- ① Select "Setup" in the menu and press "ENTER"
- ② Then use "UP" "DOWN" button to select the "DHCP" and press "ENTER"
- ③ Press "UP" "DOWN" button to select "On" or "Off" and press "ENTER" to confirm

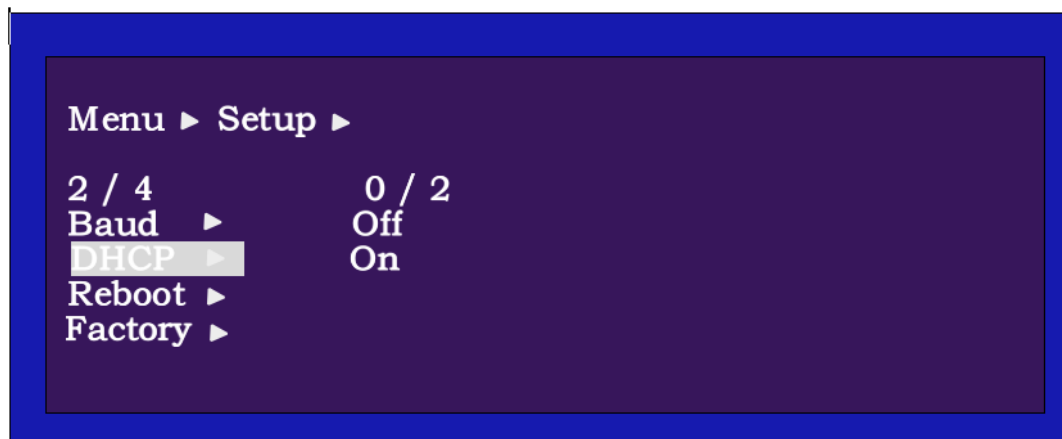

DHCP setting (P8)

3. Reboot setting

- ① Select "Setup" in the menu and press "ENTER"
- ② Then use "UP" "DOWN" button to select the "Reboot" and press "ENTER"
- ③ Press "UP" "DOWN" button to select "No" or "Yes" and press "ENTER" to confirm

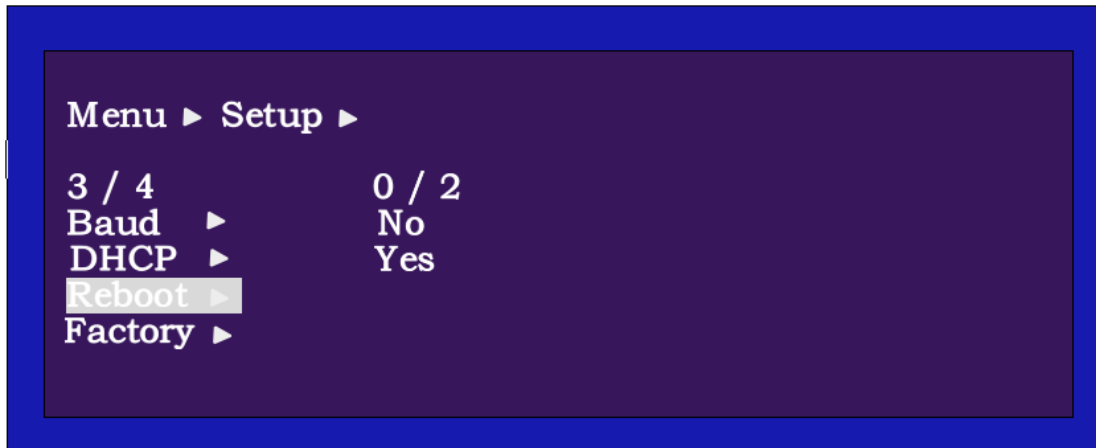

Reboot setting (P9)

4. Factory setting

- ① Select "Setup" in the menu and press "ENTER"
- ② Then use "UP" "DOWN" button to select the "Factory" and press "ENTER"
- ③ Press "UP" "DOWN" button to select "No" or "Yes" and press "ENTER" to confirm

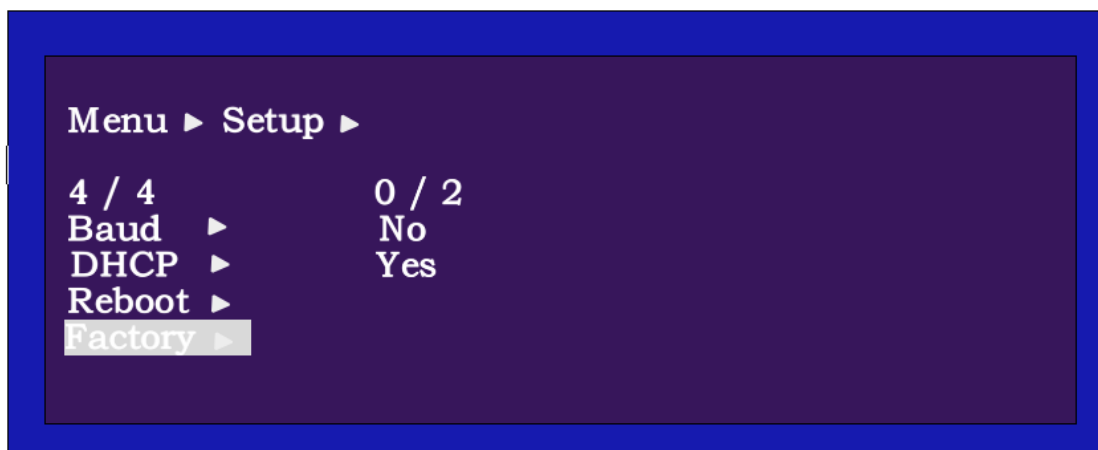

Factory setting (P10)

4.5 INFO mode Interface

Check the device information: IP or System information

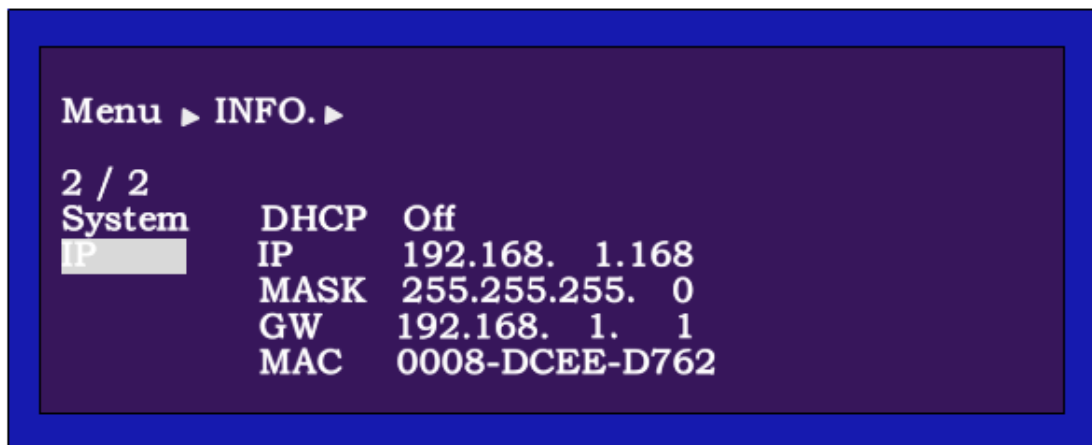

INFO mode (P11)

5. Application Diagram

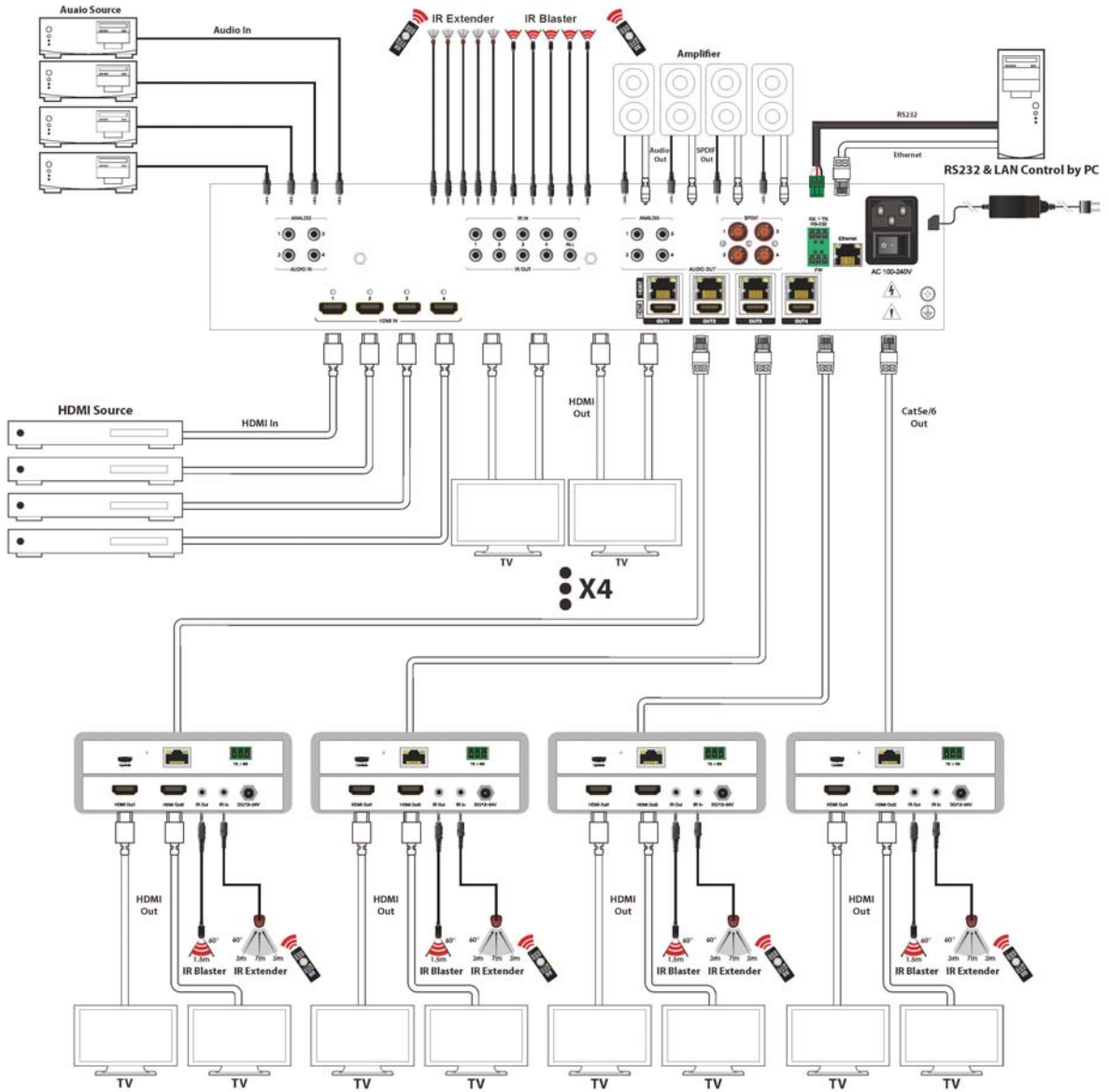

6. Remote Control Description

- ① Standby Mode
- ② Lock or Unlock the Panel Button
- ③ Choose output from 1-4
- ④ Choose all the outputs.
- ⑤ X: Turn on/off output port which you select
- ⑥ PTP button: Mirror all inputs and outputs
(Ex. Input 1 to output 1, input 2 to output 2, etc)
- ⑦ Choose input from 1-4
- ⑧ Menu (back to previous option) button
- ⑨ UP and DOWN button
- ⑩ Enter button

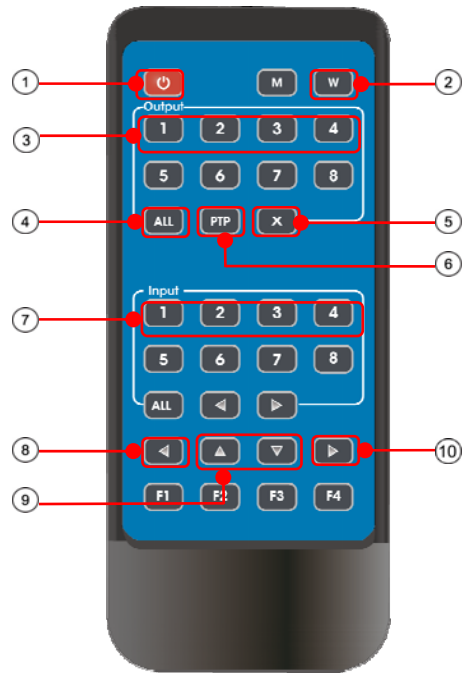

7. IR system

The matrix can pass the IR signal through the IR system to the HDMI source or pass the IR signal from the HDMI source to the HDMI sink

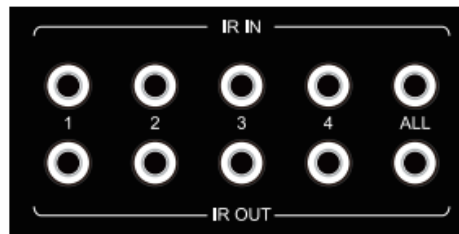

Dual way IR using:

- Step1: "IR IN" is for HDBaseT output, "IR OUT" is for input channel
- Step2: "IR IN ALL" Controlled by all input IR; "IR OUT ALL" Controlled by all output IR.
- Step3: HDBaseT receiver support connect with IR receiver to control the Matrix by remote
- Step4: Matrix IR channel "IR IN ALL" support connect with IR-RX cable to control the Matrix by remote

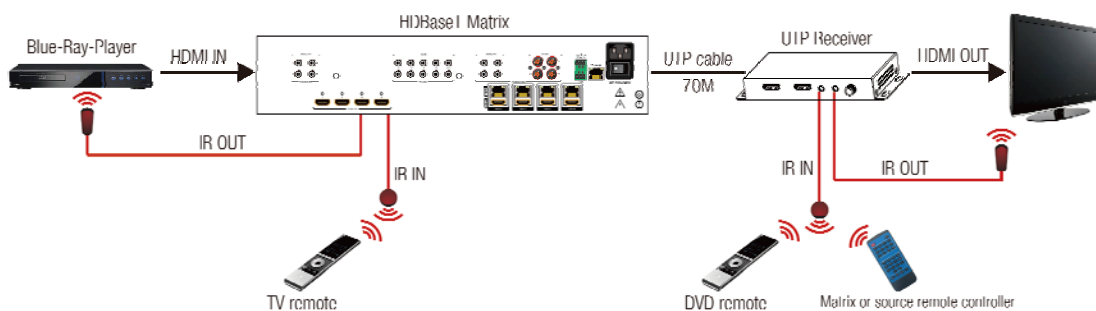

8. Command Control

Control software operation:

The serial control software is illustrated with SSCOM32 as an example.

Basic Settings:



Double-click the software in the installation package to run specifically (as shown in figure 1 below) and install the RS232 software on the computer.

Enter the main interface of the software, as shown in the figure below.

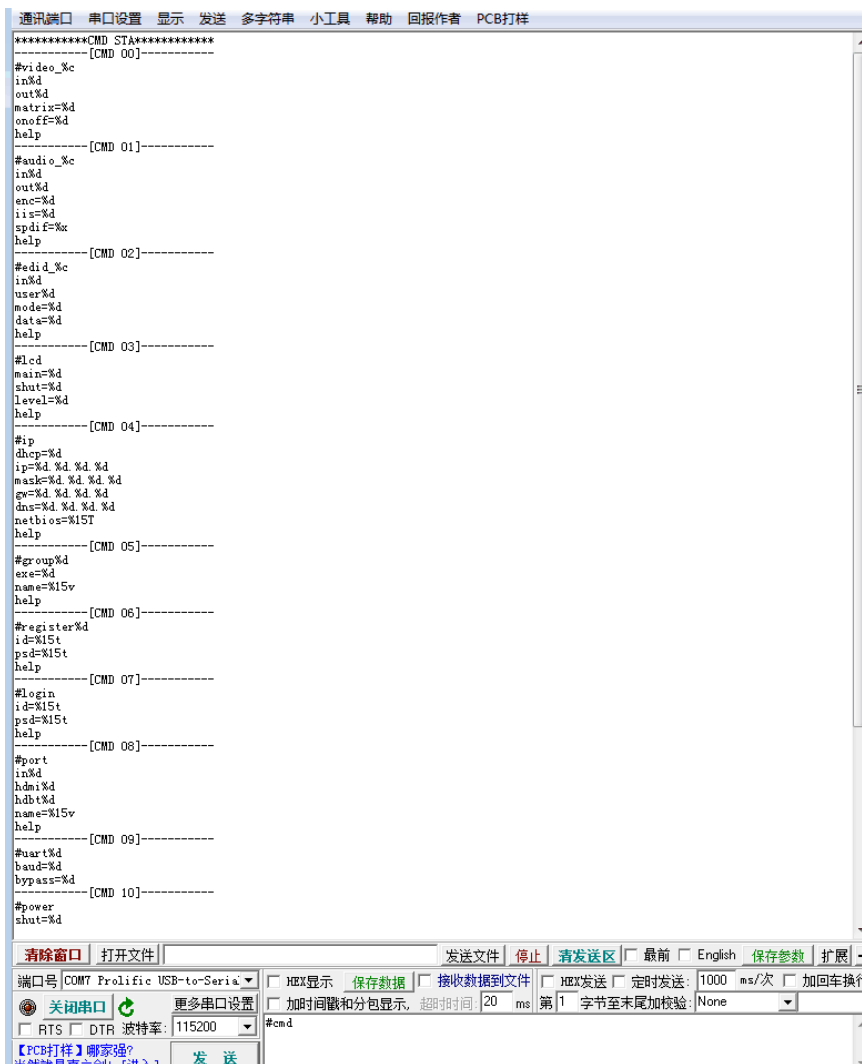

In the parameter configuration area, the serial number of serial port and PC connection is selected, and the baud rate of the communication protocol is completed: 115200 (default), data location: 8. Stop bit: 1, check bit: no, you can input the instruction in the command input area and control the machine or remote receiver.

Instructions:

1. All commands start from “#”, command head “%c”: “d” parameters, “l” lock, “s” save.
2. The “_” in the commands cannot omit. Parameter: %d: 0 means ALL.
3. Command head & Parameter1 & Parameter2... need to add one “SPACE”.

The following table is only an example. Please refer to the list of instructions.

Instruction description	instruction	parameter 1	parameter 2	parameter 3
Video channel switch	#video_%c	In%d	Out%d	matrix=%d
	d: parameters			
	l: lock s: save	0: ALL input 1~4: 1~4 input	0: ALL output 1~4: 1~4 output	1-4 : Switch to?
EDID	#EDID_%c	In%d	user%d	mode=%d
	d: parameters			
	l: lock s: save	0: ALL input 1~4: 1~4 input	0 : All EDID 1~4 EDID	0:default 1:user

Please refer to the " Command list" for details.

Example: ALL output switches to input 4.

Operation format: #video_d out0 matrix=4

9. PC Tool Control

1. Download the  [4x8 HDMI2.0 Matrix_32](#) to your computer, then open it.
2. Using USB to RS232 cable connect to the Matrix
3. Press “Search” button to find out the right port then “Open Port”

“LINK” interface description:

1. Communication parameters: RS232 port baud rate and port information can be displayed. Click the drop-down queue to set the port and baud rate from 2400 to 115200
2. Port setting: Search RS232 Port: “Open Port” is a compound switch Port. When showing “Open Port” means Disconnect. When showing “Close Port: Connecting
3. Refresh button: “Search”
4. Send instruction bar: the corresponding instruction can be sent according to the command list.
5. Instruction feedback display bar: print the log after sending corresponding commands, and operate the equipment to print as well

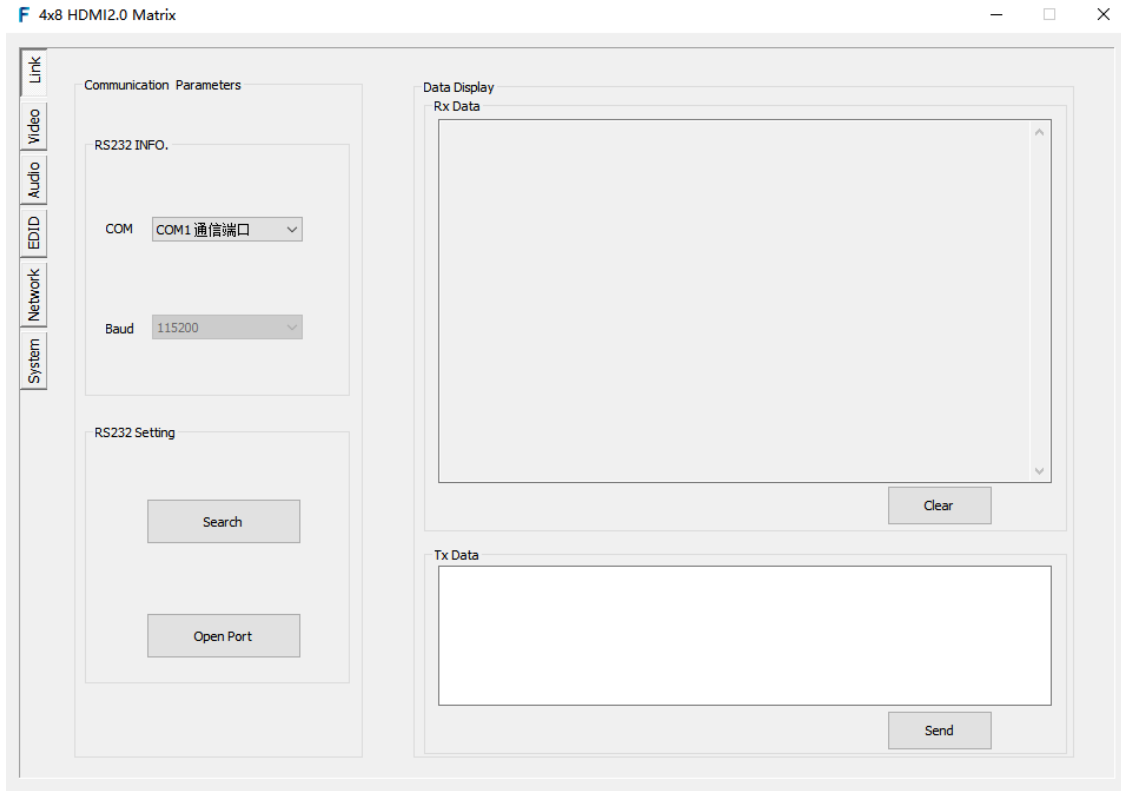

“LINK” interface (P12)

“VIDEO” interface description:

1. Output option bar: 0d>>0x represents display of current device port info.
0d: 1~4 input ports, 0x: 1~4 output ports, all means all selection, support multiple selection, single selection
2. Input options: 01~04 means input port 1~4
3. Application Preset: 8 application preset are supported, save: 8 different application scenarios can be saved, and recall: call any one of them
4. Rename: HDMI, HDBT, input and other port names can be modified. A total of 4 names are supported for each port. Mouse over one of the output options displays the HDMI and HDBT names, and mouse over one of the input options displays the input name.

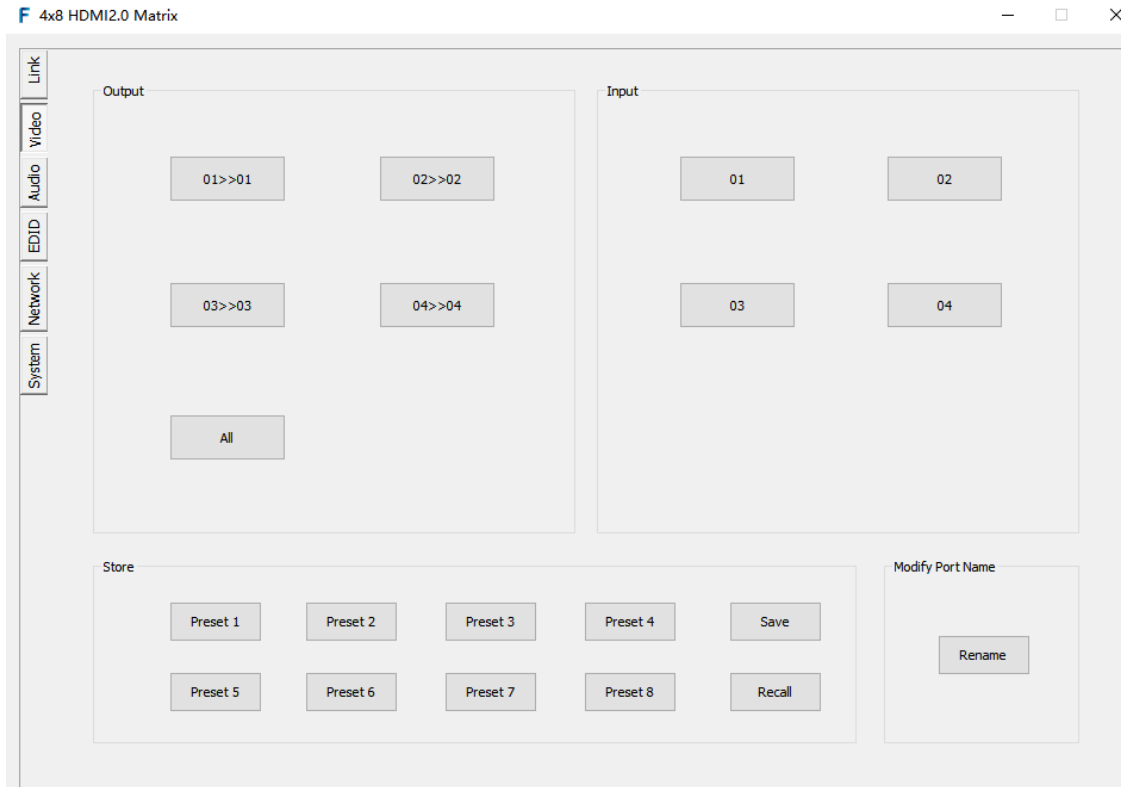

Video switch interface (P13)

Usage:

1. Video switch: select any of the output options and then click any of the input options to switch directly, for example: click 04>>01 and select 01. The output 1 TV will display the input 1 source
2. Application Preset: users can switch and save in the application preset according to the commonly used video, and there is no need to switch the scenes for direct invocation next time. For example, after clicking all, select 04; after clicking preset1, click the red box again to save; after clicking preset1, select the green box recall to call

“AUDIO” interface description:

1. Input audio option bar: HDMI audio input and analog audio input can be selected; H represents the audio of HDMI itself; A represents the mixing of analog audio
2. Output audio option bar: select analog audio separation, spdif audio separation, A represents analog audio separation, S represents digital audio separation
3. The blue background is selected, and gray indicates mute. It can be set with single, multiple or all options

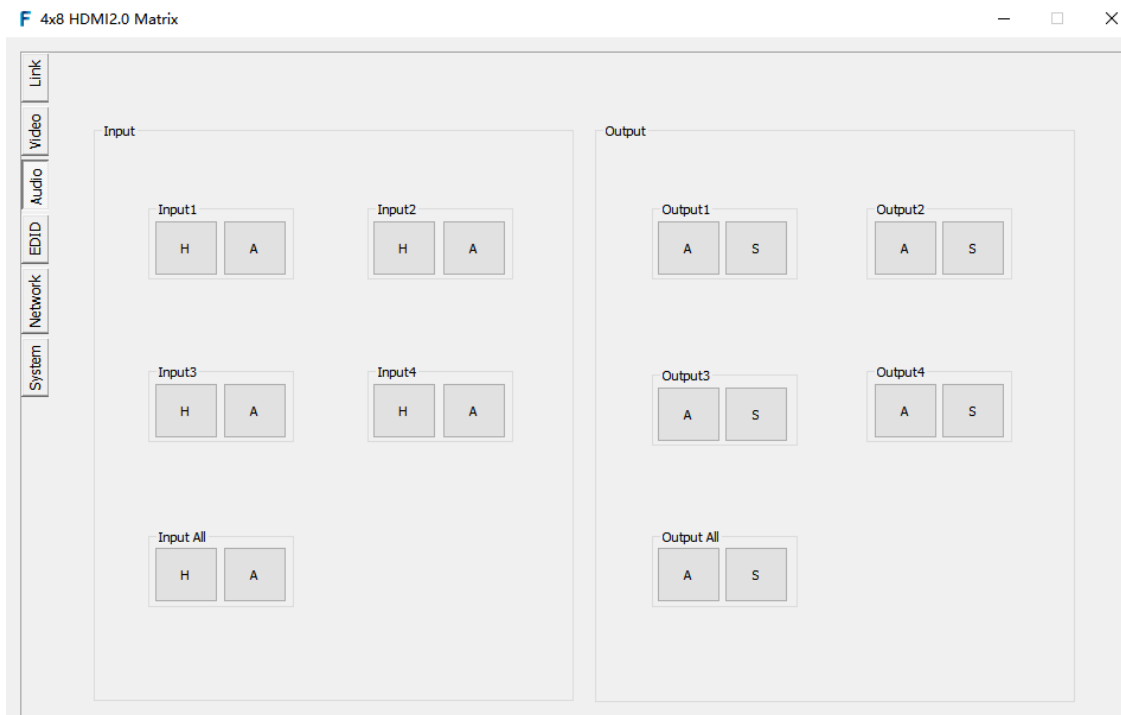

Audio switch interface (P14)

“EDID” interface description:

1. Input option bar: 01>>01 is the port status, for example: 01>>01; 01> means the first HDMI port EDID, and >01 means the input port, which means the first HDMI port EDID is copied to the first signal source (in HDMI mode).
2. EDID option bar: four modes can be selected in the Output Mode drop-down box, User EDID (editable), built-in Default EDID, Output port HDMI EDID, Output port HDBT EDID

3.EDID display bar: displays the currently set EDID information

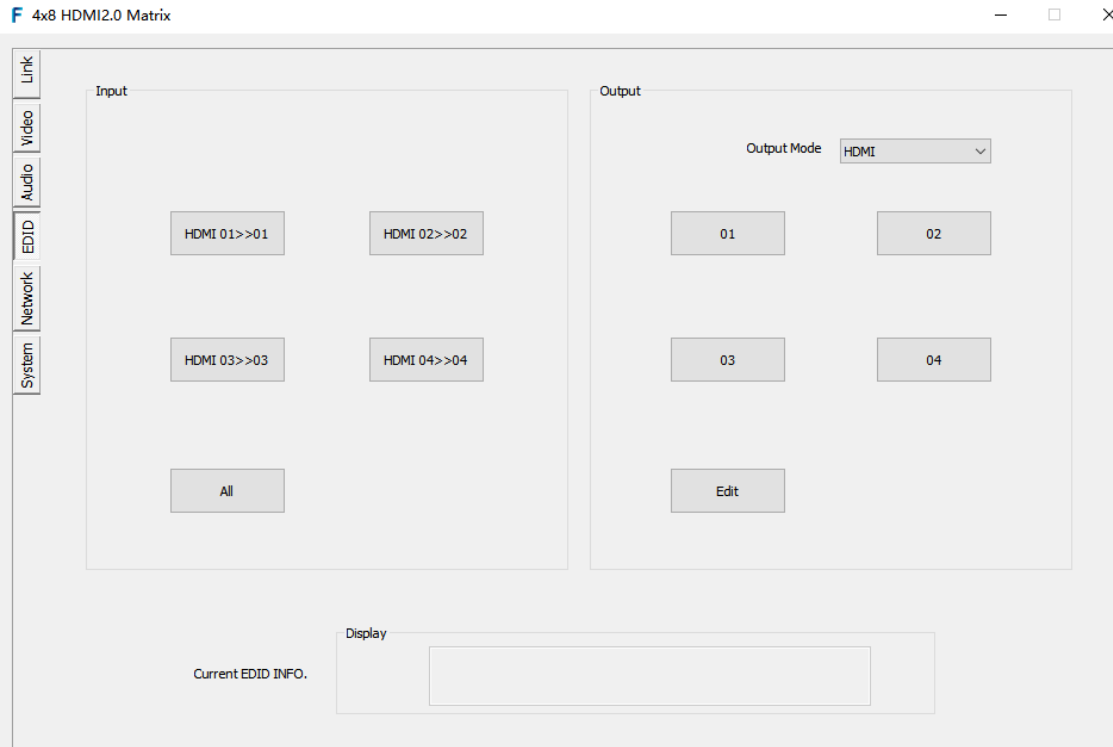

EDID interface (P15)

Usage:

1. Copy EDID:

Select the corresponding Input port in the Input (multiple options are available, you need to select All and click the All button)

Select the Output port is HDMI (Default/User/HDBT) in the Output Mode drop-down box.

Select the corresponding Output port in the Output to complete the operation

2. The user to edit EDID

Description: copy the Output EDID(currently only supports HDMI and HDBT) to the user-defined EDID(User Mode in Output Mode)

Specific steps: click Edit in the lower right corner of the Output dialog box, and the EDID Edit Page dialog box pops up. Select the corresponding User mode port in the User Option area (multiple options are available). In the Save Option area, select any HDBT or HDMI Output port (single Option) to copy the Output port information to the selected User port.

3. Click Exit or X to Exit the interface
4. Default EDID: 01-04 EDID can be selected after clicking default

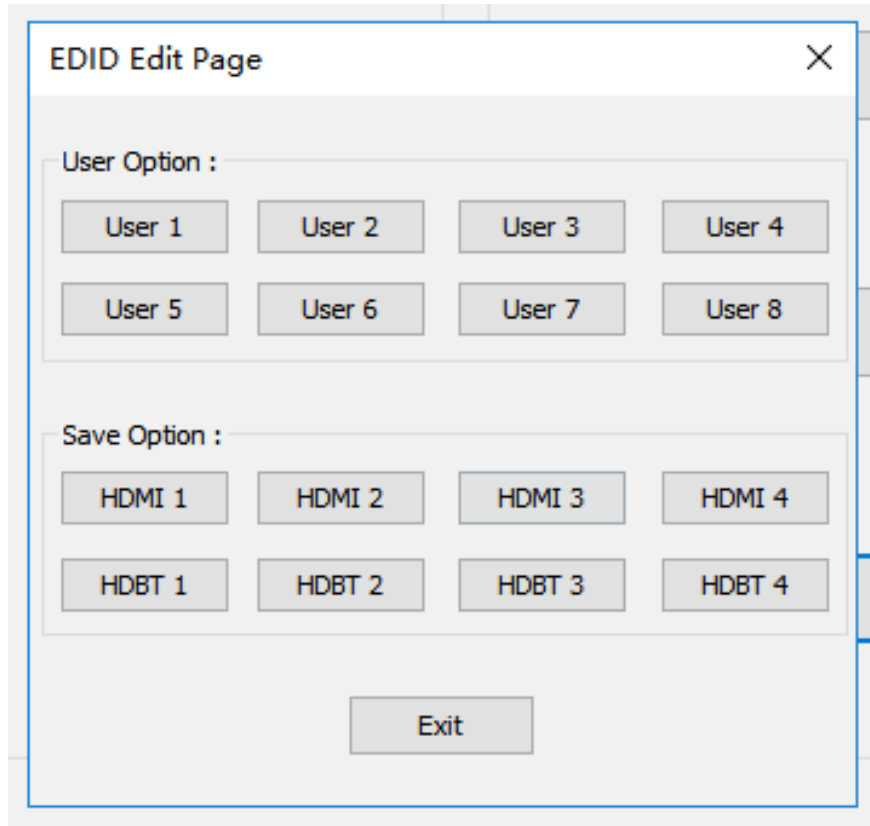

EDID Edit Page (P16)

“Network” interface description:

1. Network INFO: MAC address can only be displayed and cannot be modified
2. DHCP off state: when using static IP, IP and other addresses can be modified. After apply is applied, it needs to log in the GUI interface again and use the new IP address
3. DHCP on state: use the key switch to switch to DHCP on state, use dynamic IP, IP and other addresses below, and the dialog box turns gray.
Can not be modified, can display the current IP address information
4. DHCP switch is a compound switch, and DHCP On and DHCP Off are two choices. When Off is displayed, it means the current state is static; when On is displayed, it means the current state is dynamic

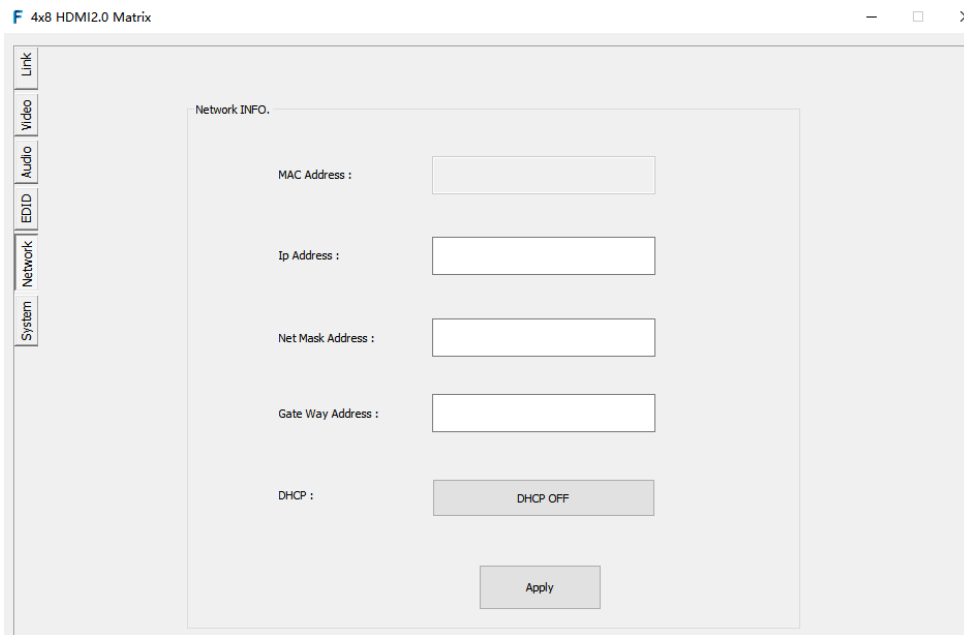

Network interface(P17)

“System” interface description:

- 1.Product Model :(can be modified)
2. Firmware: software version (that cannot be modified)
3. Product type: original product type (cannot be modified)
4. Reboot: reboot the device
5. Factory: restore factory Settings
6. Operation steps: click reboot (factory) and the dialog box system restart (default setting) will pop up. Click OK

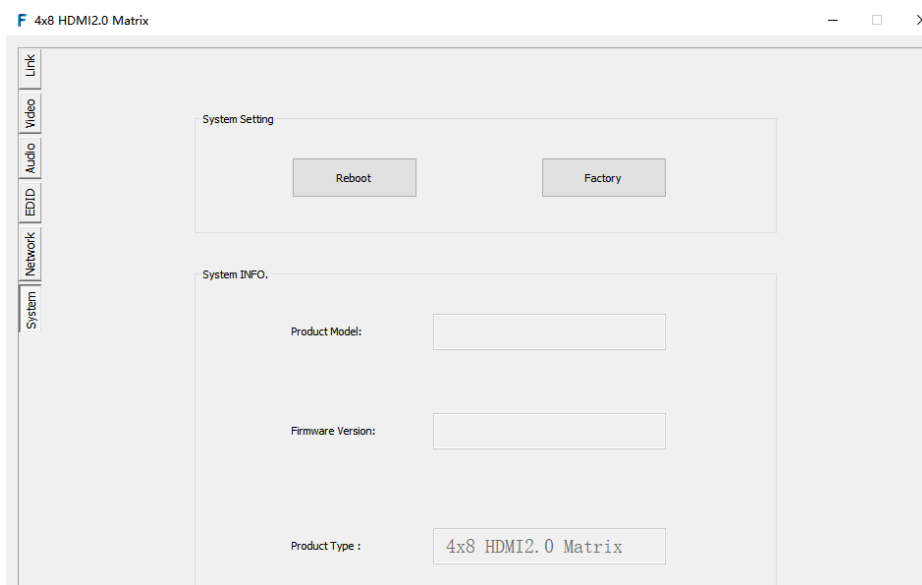

System interface(P18)

10. Web Control

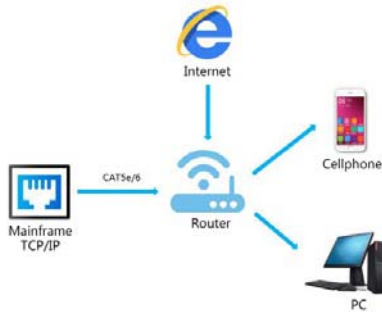

10.1 Change the IP address of your PC.

- 1). Connect the Ethernet port of matrix to the Ethernet port on PC by a crossover cable with RJ45 connectors.
- 2). Configure your PC as follows:
 - ① Click **Start > Control Panel > Network and Sharing Center**.
 - ② Click **Change Adapter Settings**.
 - ③ Highlight the network adapter you want to use to connect to the device and click **Change settings of this connection**.
- 3). The local Area commotion properties window for Network selection appears as below:
- 4). Click the Highlight **Internet Protocol Version 4 (TCP/IPv4)**.
- 5). Click **Properties**.
- 6). Select **Use the following IP Address** for static IP addressing and fill in the details.
For TCP/IPv4 you can use any IP address in the range 192.168.1.1 to 192.168.1.255 (excluding 192.168.1.168).
- 7). Click **OK**.
- 4). Click **Close**.

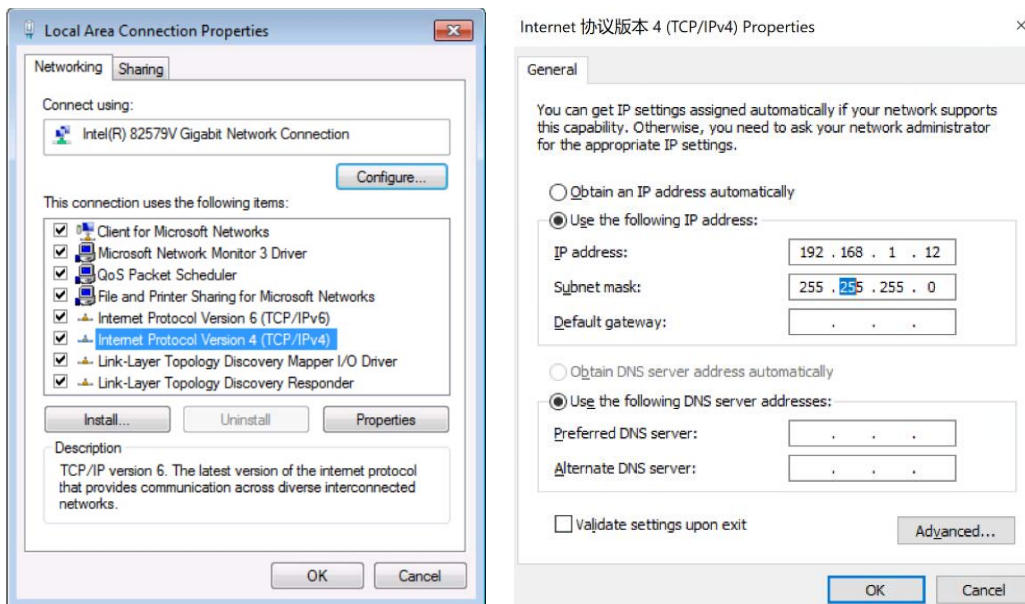

Web Control (P19)

(Default IP Address: 192.168.1.168; MASK: 255.255.255.0; Gateway:192.168.1.1;
MAC:0004-DCCA-CF3F)

10.2 Enter Web and Control.

1) Enter the default IP address of the matrix: 192.168.1.168.

2) You will see following picture and control:

(User Name: admin; Password:123456)

Note: web control is recommended to use Google, fire fox, IE11 and above browsers, using other browsers may not be compatible

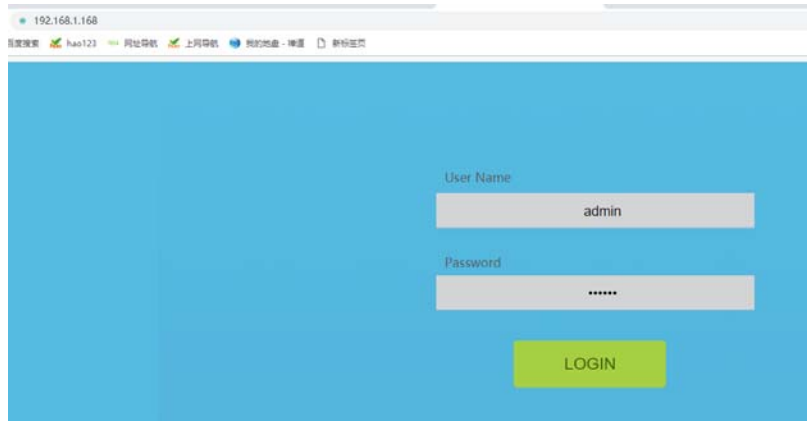

Web Control (P20)

“VIDEO” interface description:

1. Output selection bar: 01>>04~01>>04, input option bar: 01~04 means input port; all means select all

2. Video switch: First select the output then input, gray means selected, and then click apply to complete the switch

For example: select 03>>01 then click 01, and finally click apply

Blue box will be displayed when signal source or TV is connected

3. Scenario application

Save: first select any one of preset 1-8, gray means selected, and then click save to complete the save

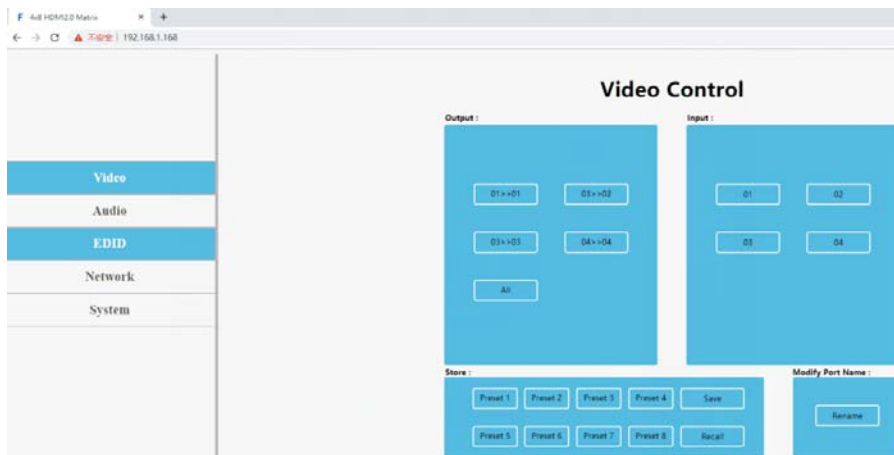

Web control (P21)

5. Rename: modify input/output port name. Operation steps: click into the interface of port modification, enter the name of modification in the new name column and click apply

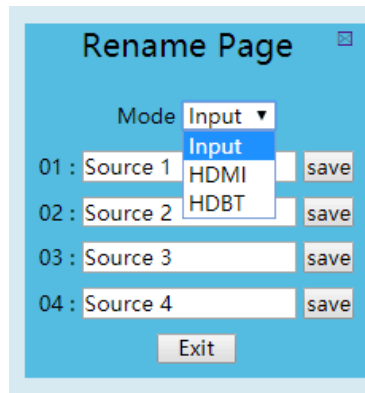

“AUDIO” interface description:

1. Input audio mixing: H means HDMI audio mixing, A means analog audio mixing, 01~04 means audio input port, All: all selected
2. Output audio separation: A means analog audio separation; S means spdif audio separation; 01~04 means audio output port; All: all selected
3. Gray means selected

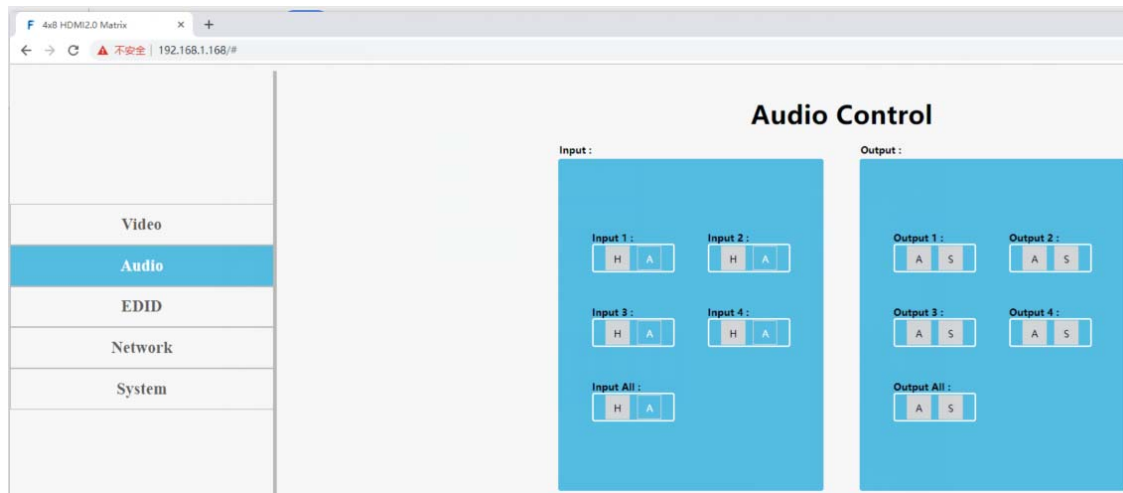

Web control(P22)

“EDID” interface description:

EDID copy: HDMI01>>01 means copy output HDMI01’s EDID;
 HDBT01>>01 means copy HDBT01’s EDID

Gray means selected

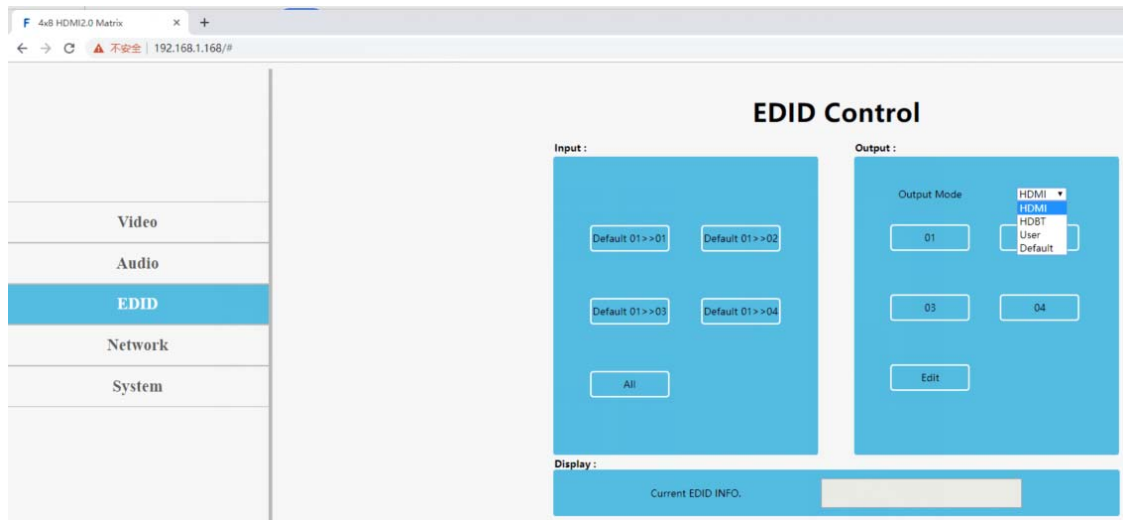

Web control(P23)

User EDID: user1~8 means the user’s EDID. A total of 8 EDID can be saved.
 Click edit to enter the user setting interface, select any port in the save option, then click save to one of the user ports, and then click apply to confirm



Web control(P24)

“Network” interface description:

1. The interface displays Mac address, IP address, sub code mask and gateway address
- 2.DHCP can only modify IP address, sub net mask and gateway in the off state, and does not support any parameter modification in the on state
- 3.DHCP switch: click Apply after click the white scroll bar to modify

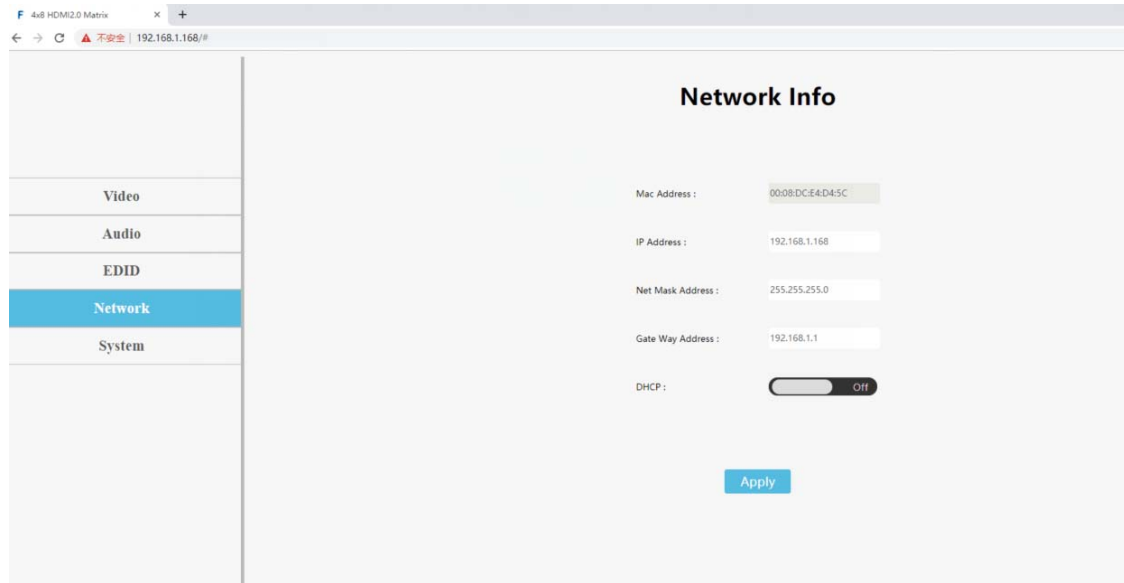

Web control(P25)

System interface description:

The user name means change the logged-in user name. New password means enter the new password in the login interface, age password means enter the new password again, and click apply to complete the modification after entering

- (1.Matrix has 5 default accounts: admin~admin4, password: 123456. Account has level permissions
2. Only supports changing 6-15 characters of the account password in the form of letters, underscores and Numbers.)

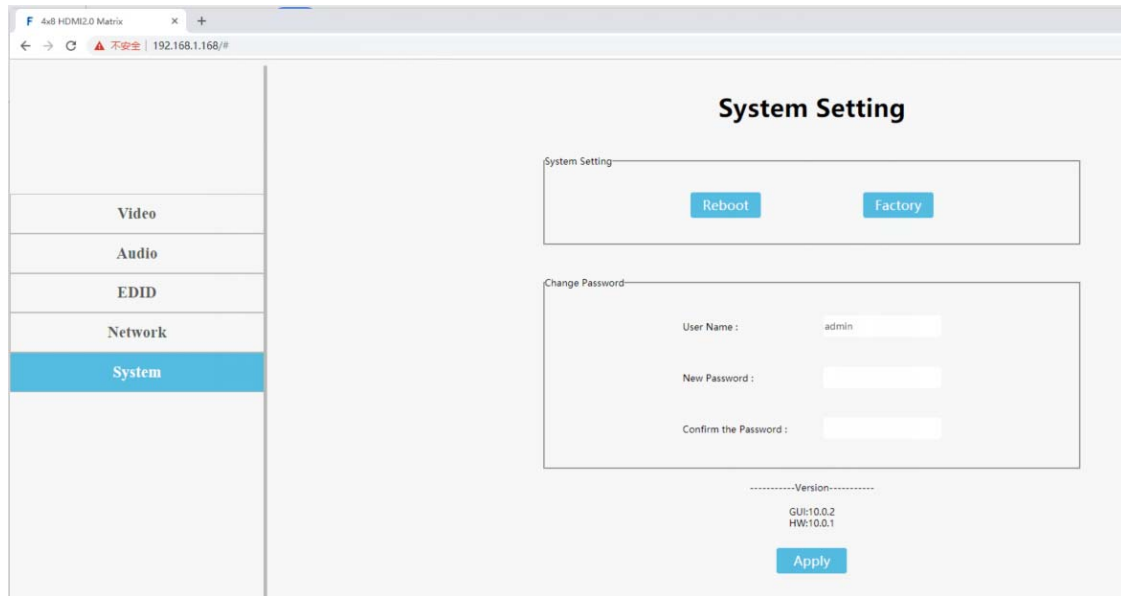

Web control(P26)

11.RS232 Pass through

By RS232 Command , the matrix can send RS232 data to control the receivers ,also the receiver can send RS232 data to control the Matrix.

Please refer to the command list which included in the manual.

12. RS232 Online upgrading Firmware

1. Use serial port upgrade, and the host dial code is pre- adjusted to the right to enter the serial port upgrade mode;
- 2.RS232/Micro USB connection computer and product, open special upgrade software, click "Refresh" to make serial number Refresh;
- 3.COM port to choose the port connected with the product;
4. The baud rate setting is consistent with the host baud rate (default 115200);
5. Upgrade instructions in the upgrade instruction box (some instructions are as follows);
A1 means MCU;
A1 01 means GUI;
F0 01 means HTML.
6. Click on the "...Select the upgrade file for download;
7. Click "Update" and the system starts to upgrade;
4. The updated information box will prompt "Succeed" information when the upgrade is completed, and the representative program has been upgraded successfully.

Note:Before burning, it is confirmed that HDMI/HDBT input and export are suspended.If other devices are connected, the host will automatically stop the upgrade.

If the upgrade progress bar is stopped in the middle of the upgrade, then the host will need to be rebooted, then the serial port will be upgraded.

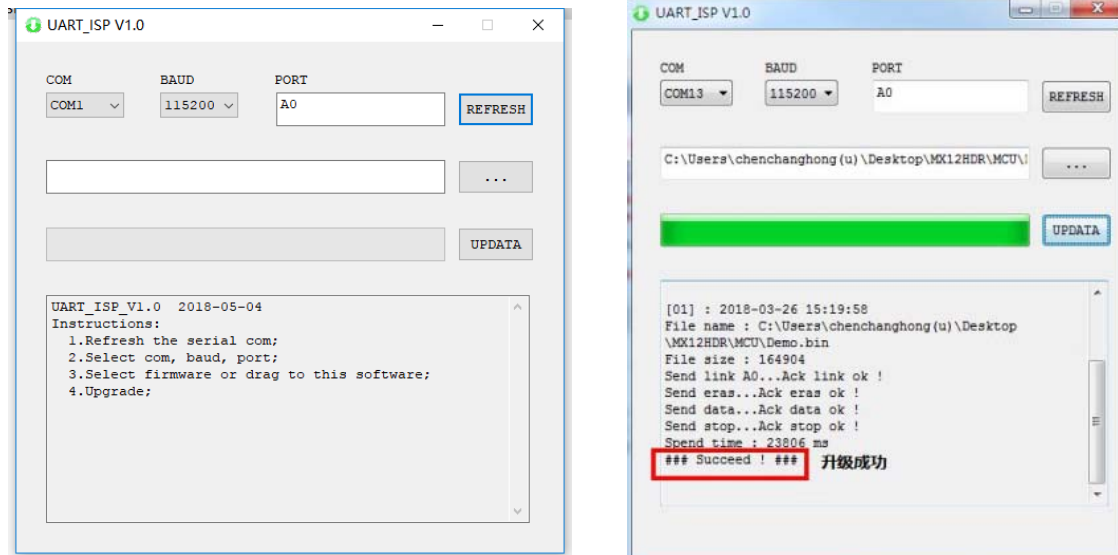

⚠️ Note: Need an adapter for Phoenix terminal to RS232 port.



MAINTENANCE

Clean this unit with a soft, dry cloth. Never use alcohol, paint thinner or benzene to clean this unit.

PRODUCT SERVICE

(1) **Damage requiring service:**

The unit should be serviced by qualified service personnel if:

- (a) The DC power supply cord or AC adaptor has been damaged;
- (b) Objects or liquids have gotten into the unit;
- (c) The unit has been exposed to rain;
- (d) The unit does not operate normally or exhibits a marked change in performance;

The unit has been dropped or the cabinet damaged.

(2) **Servicing Personnel:** Do not attempt to service the unit beyond that described in these operating instructions. Refer all other servicing to authorized servicing personnel.

(3) **Replacement parts:** When parts need replacing ensure the servicer uses parts specified by the manufacturer or parts that have the same characteristics as the original parts. Unauthorized substitutes may result in fire, electric shock, or other Hazards.

(4) **Safety check:** After repairs or service, ask the servicer to perform safety checks to confirm that the unit is in proper working condition.

WARRANTY

If your product does not work properly because of a defect in materials or workmanship, our Company (referred to as "the warrantor") will, for the length of the period indicated as below, **(Parts)2 Year, Labor(90) Days** which starts with the date of original purchase ("Limited Warranty period"), at its option either (a) repair your product with new or refurbished parts, or (b) replace it with a new or a refurbished product. The decision to repair or replace will be made by the warrantor.

During the "Labor" Limited Warranty period there will be no charge for labor.

During the "Parts" warranty period, there will be no charge for parts. You must mail-in your product during the warranty period. This Limited Warranty is extended only to the original purchaser and only covers product purchased as new. A purchase receipt or other proof of original purchase date is required for Limited Warranty service.

MAIL-IN SERVICE

When shipping the unit carefully pack and send it prepaid, adequately insured and preferably in the original carton. Include a letter detailing the complaint and provide a day time phone and/or email address where you can be reached.

LIMITED WARRANTY LIMITS AND EXCLUSIONS

1) This Limited Warranty **ONLY COVERS** failures due to defects in materials or workmanship, and **DOES NOT COVER** normal wear and tear or cosmetic damage.

The Limited Warranty **ALSO DOES NOT COVER** damages which occurred in shipment, or failures which are caused by products not supplied by warrantor, or failures which result from accidents, misuse, abuse, neglect, mishandling, misapplication, alteration, faulty installation, set-up adjustments, misadjustment of consumer controls, improper maintenance, power line surge, lightning damage, modification, or service by anyone other than a Factory Service center or other Authorized Servicicer, or damage that is attributable to acts of God.

2) **THERE ARE NO EXPRESS WARRANTIES EXCEPT AS LISTED UNDER "LIMITED WARRANTY COVERAGE". THE WARRANTOR IS NOT LIABLE FOR INCIDENTAL OR CONSEQUENTIAL DAMAGES RESULTING FROM THE USE OF THIS PRODUCT, OR ARISING OUT OF ANY BREACH OF THIS WARRNTY.** (As examples, this excludes damages for lost time, cost of having someone remove or re-install an installed unit if applicable, travel to and from the service, loss of or damage to media or images, data or other recorded content. The items listed are not exclusive, but are for illustration only.)

3) **PARTS AND SERVICE, WHICH ARE NOT COVERED BY THIS LIMITED WARRANTY, ARE YOUR RESPONSIBILITY.**